

48" ROUND DINING TABLE

DH-0704

BREEZESTA tm
Recycled Poly Furniture

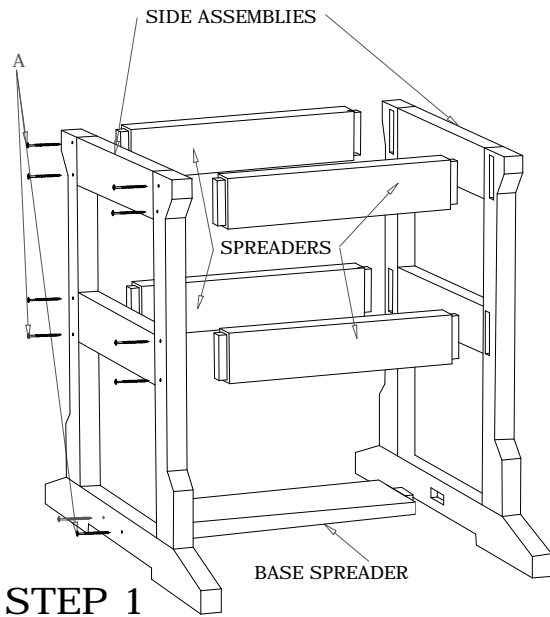

STEP 1

Attach Side Assemblies to Spreaders by placing the tenon into the mortise (pocket) and attaching with screws (A) as shown.

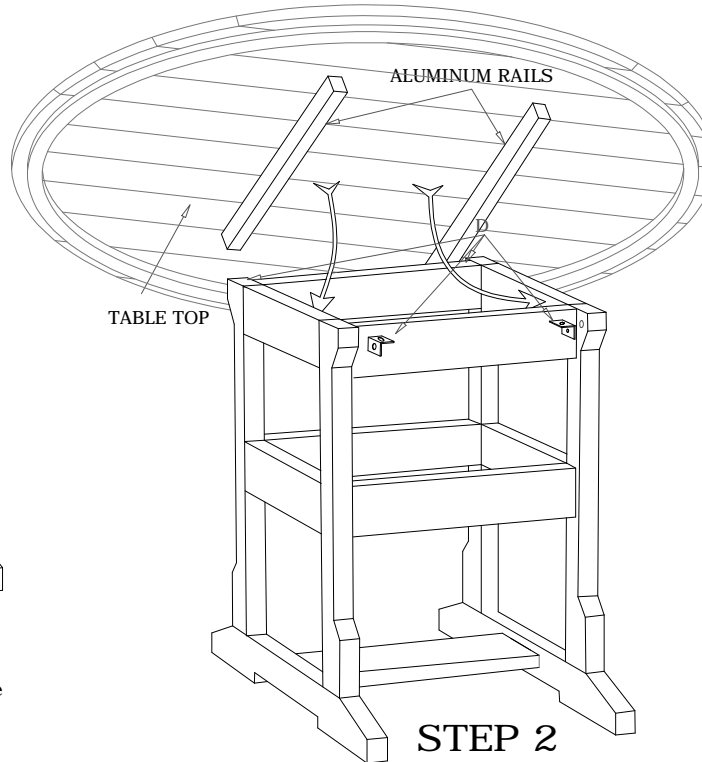

Place the table top on the base so that the Aluminum Rails on the table top fit within the base as shown above. Place Ell Brackets (D) in the corners, as shown.

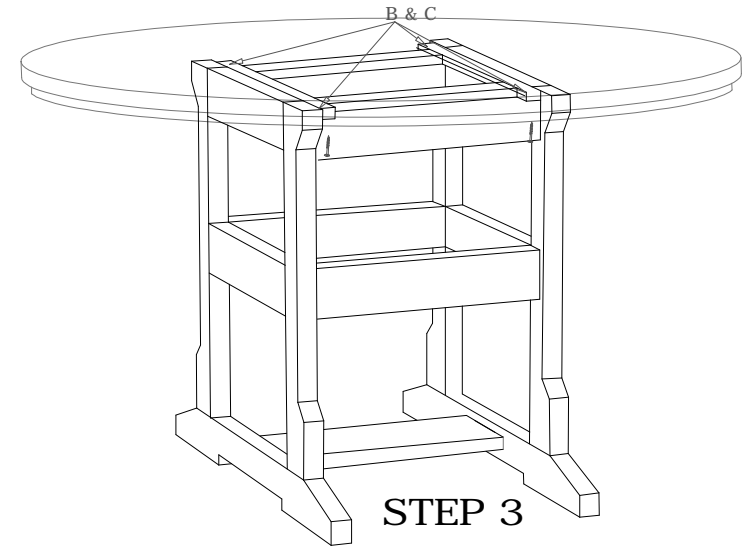

Attach table top to base using uncolored screws (B) through the underside of the Ell Brackets (D), and to legs using uncolored screws (C) through the side of the Ell Brackets.

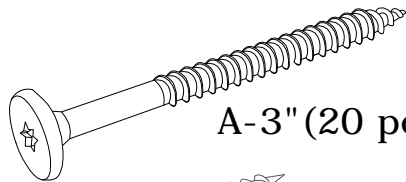

A-3" (20 pcs.) colored

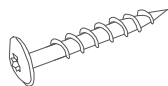

B-7/8" (4 pcs.) uncolored

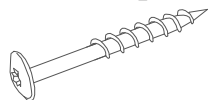

C-1.5" (4 pcs.) uncolored

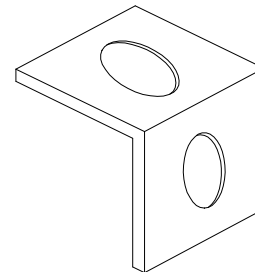

D-Metal Ell Bracket (4 pcs.)

- LIST OF PARTS
- Side Assemblies (2)
 - Spreaders (4)
 - Base Spreader (1)
 - Table Top (1)
 - Colored Screws "A" (20)
 - Un-Colored Screws "B" (4)
 - Un-Colored Screws "C" (4)
 - Metal Ell Brackets "D" (4)
 - Insert Bit Tool (1)